

STK-084,086, 085-105

thick film hybrid IC

348

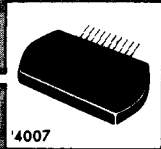

4007

50 to 30W min AF POWER

Features

- © IMST, 1 Channel by 2 Power Supply.
- AF Output Power STK-084: 50 Wmin.
STK-085-105: 60 Wmin.
STK-086: 70 Wmin.
- Capable of setting protector for load shorting and tone controller.

MAXIMUM RATINGS / Ta=25°C

		STK-084	STK-085 -105	STK-086	unit
Maximum Supply Voltage	V _{CC} max	±50	±55	±55	V
Collector Current	I _C max	7	—	7	A
Thermal Coefficient	θ _{j-c} (T _C =25°C)	1.7	—	1.4	°C/W
Operating Case Temperature	T _C	85	105	85	°C
Storage Temperature	T _{sgt}	-30 to +100	-30 to +105	-30 to +100	°C

RECOMMENDED OPERATION CONDITION / Ta=25°C

		STK-084	STK-085 -105	STK-086	unit
Recommended Supply Voltage	V _{CC}	±35	±38	±42	V
Load Resistance	R _L	→	→	8	ohm

OPERATION CHARACTERISTICS / Ta=25°C, recommended V_{CC} supplied, R_L=8 ohm, R_g=600 ohm, VG=26.4dB

		STK-084	STK-085 -105	STK-086	unit
Quiescent Current	I _{CCO}	→	→	100	mAmax
Output Power	P _o	50	60	70	Wmin
	THD=0.2%, f=20 to 20 kHz				
Distortion	THD	→	→	0.2	%max
	f=20 to 20 kHz rated output power				
Frequency Response	f	→	→	10 to 100k	Hz
	P _o =1W, +0 -1 dB				
Input Resistance	r _i	→	→	52k	ohm
	P _o =1W, f=1 kHz				

EQUIVALENT CIRCUIT

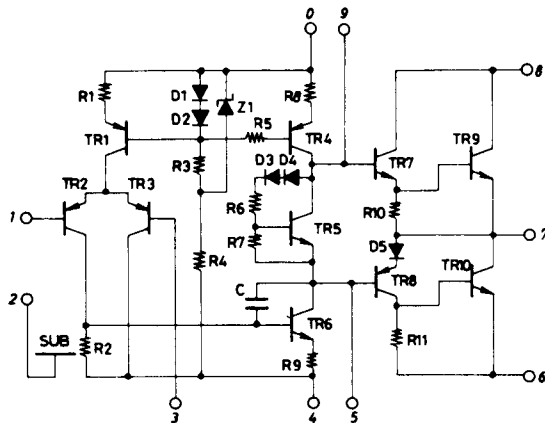

APPLICATION: AF Power Amp.

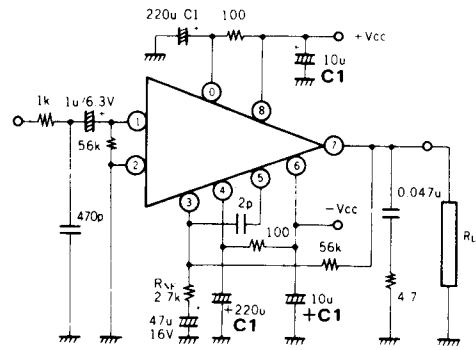

	C1
STK-084	50V
STK-085-105 STK-086	63V

See the operation characteristics on this specification.